

Model	L 1	L Tot.	Model	L 1	L Tot.
UL0503	87	217.5	UL0503B	102.5	233
UL0505	129	259.5	UL0505B	144.5	275
UL0508	171	301.5	UL0508B	190.5	321
UL0511	217	347.5	UL0511B	234.5	365

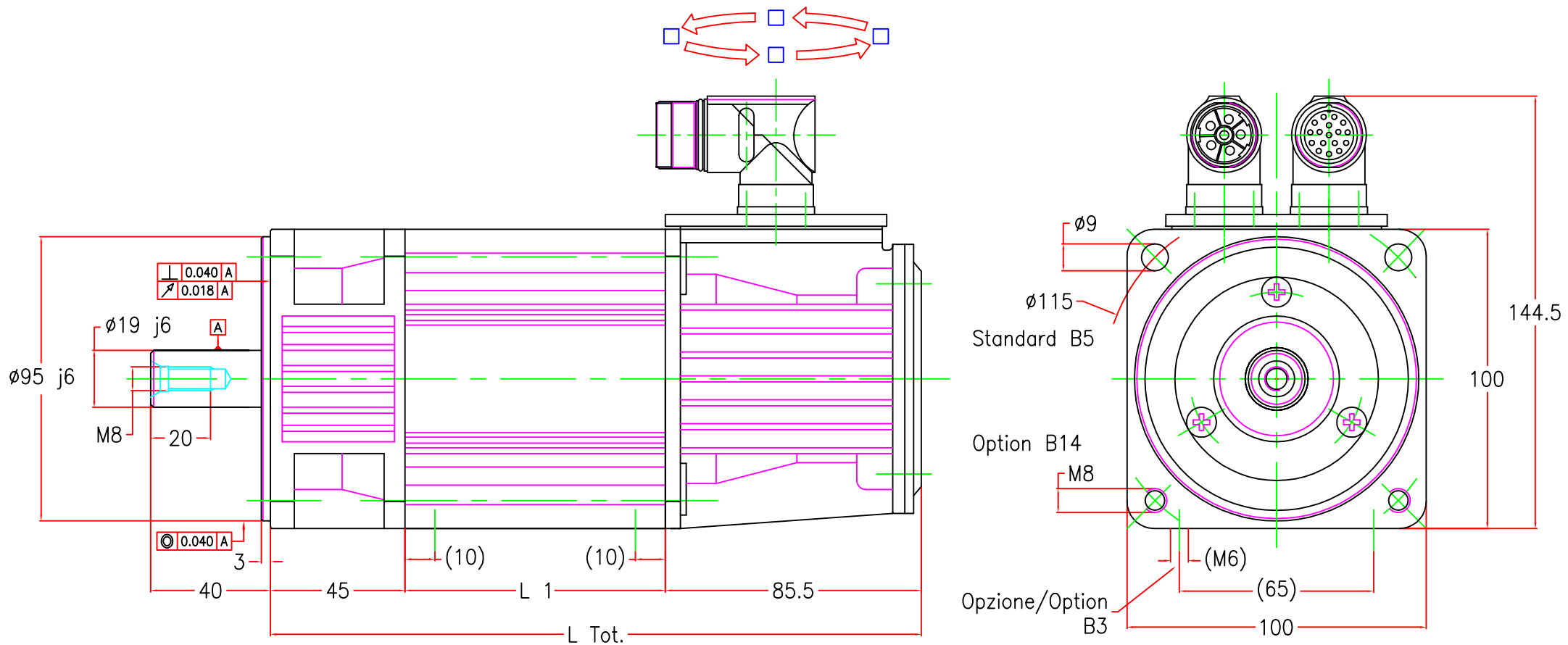

R.C.V. s.r.l.
 V. Cavour, 7 z.i.
 10070 Robassomero (TO) I
 Tel. 0039.0119241201
 Fax 0039.0119241176
 E-Mail: tecnico@rcv-srl.it



Model	L 1	L Tot.	Model	L 1	L Tot.
UL0503	87	217.5	UL0503B	102.5	233
UL0505	129	259.5	UL0505B	144.5	275
UL0508	171	301.5	UL0508B	190.5	321
UL0511	217	347.5	UL0511B	234.5	365



R.C.V. s.r.l.
 V. Cavour, 7 z.i.
 10070 Robassomero (TO) I
 Tel. 0039.0119241201
 Fax 0039.0119241176
 E-Mail: tecnico@rcv-srl.it



R.C.V. srl

V. Cavour, 7 z.i.
10070 ROBASSOMERO (TO)
Tel. +39 011 9241201 (4 linee r.a.)
Fax +39 011 9241176
E-Mail info@rcv-srl.it
http:// www.rcv-srl.it

ULTRACT - UL05

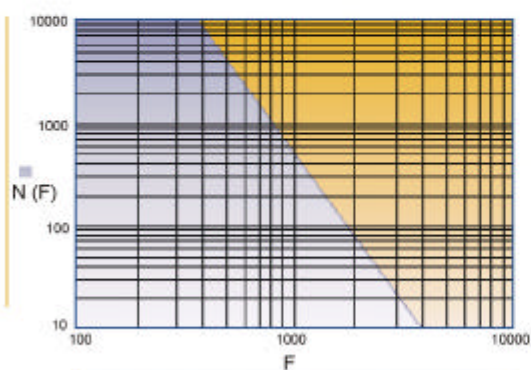
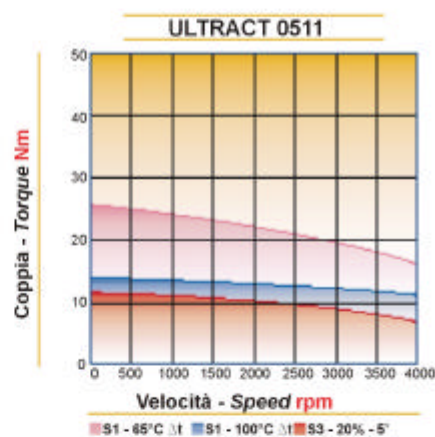
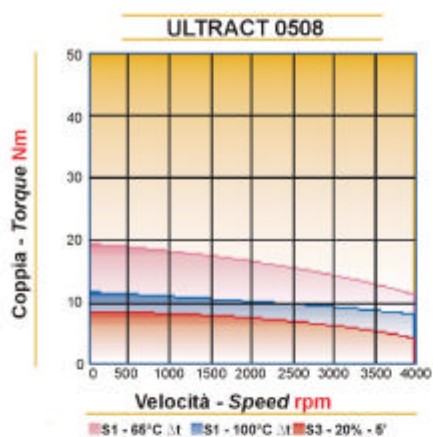
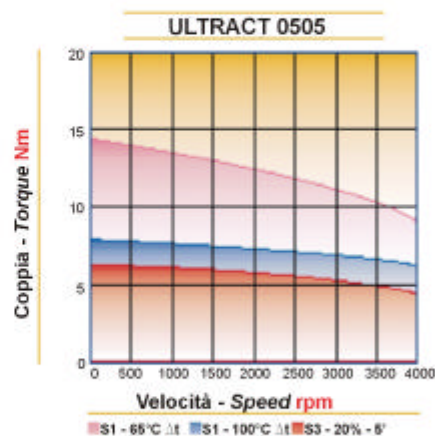
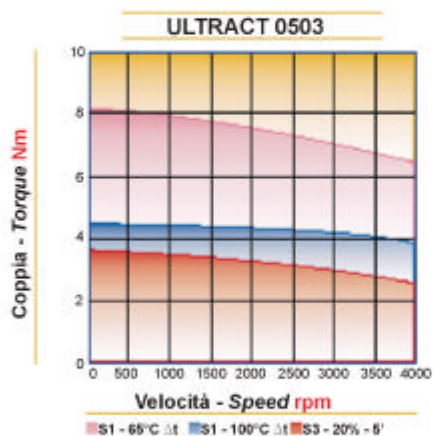

Vita (milioni di giri) dei cuscinetti in funzione del carico radiale (N) applicato alla mezzera della sporgenza d'albero del motore

Bearing calculated lifetime (million of rays) versus radial load (N) applied in the middle of the shaft

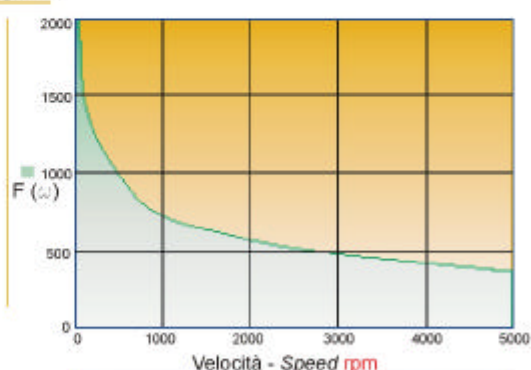

Massimo carico radiale (N) ammesso in funzione della velocità (rpm) per una vita di 30000 ore

Maximum radial load (N) versus speed (rpm) referred to 30000 h bearing lifetime