

Model	L 1	L Tot.	Model	L 1	L Tot.
UL0704	66	217	UL0704B	104	255
UL0708	90	241	UL0708B	127	278
UL0711	117	268	UL0711B	154	305
UL0714	134	285	UL0714B	176	327
UL0719	193	344	UL0719B	229	380
UL0726	245	396	UL0726B	281	432
UL0748	290	441	UL0748B	326	477

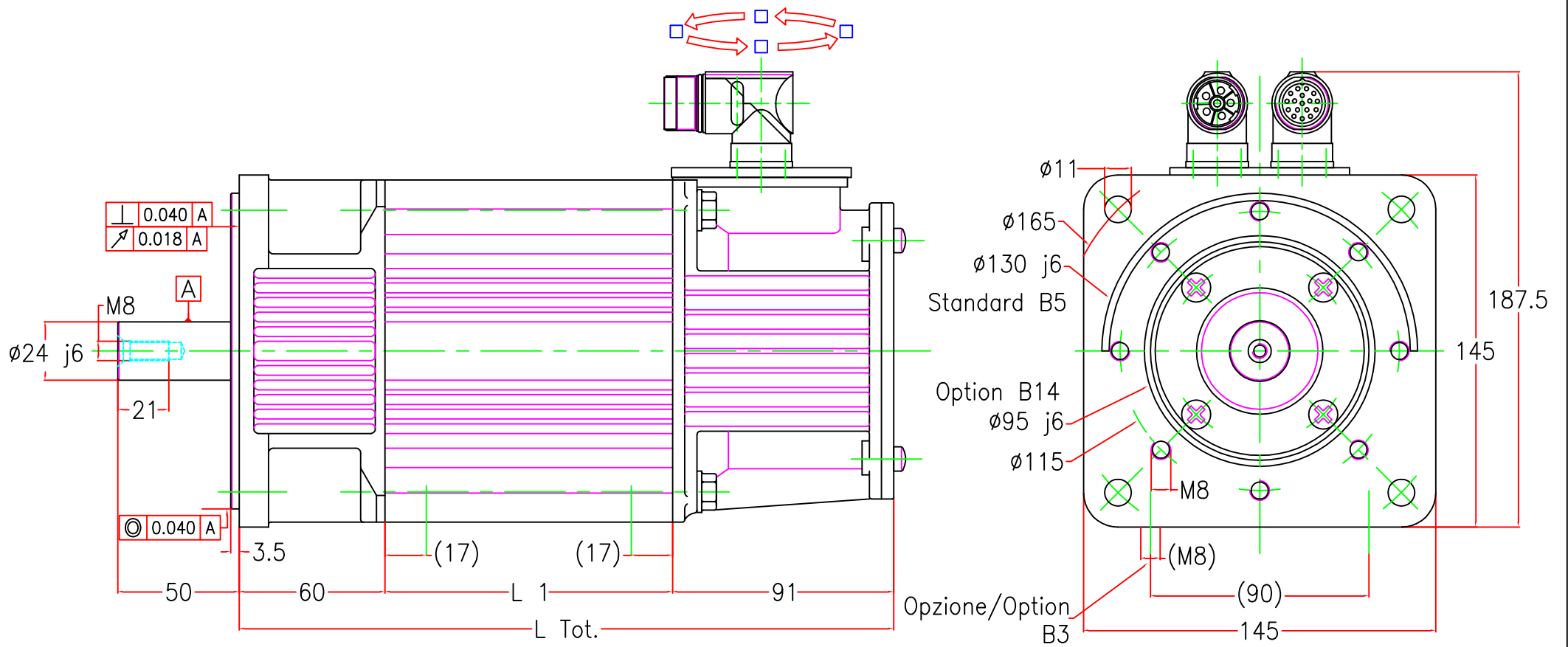

R.C.V. s.r.l.  
 V. Cavour, 7 z.i.  
 10070 Robassomero (TO) I  
 Tel. 0039.0119241201  
 Fax 0039.0119241176  
 E-Mail: tecnico@rcv-srl.it



Model	L 1	L Tot.	Model	L 1	L Tot.
UL0704	66	217	UL0704B	104	255
UL0708	90	241	UL0708B	127	278
UL0711	117	268	UL0711B	154	305
UL0714	134	285	UL0714B	176	327
UL0719	193	344	UL0719B	229	380
UL0726	245	396	UL0726B	281	432
UL0748	290	441	UL0748B	326	477



R.C.V. s.r.l.  
 V. Cavour, 7 z.i.  
 10070 Robassomero (TO) I  
 Tel. 0039.0119241201  
 Fax 0039.0119241176  
 E-Mail: tecnico@rcv-srl.it



**R.C.V. srl**

V. Cavour, 7 z.l.  
 10070 ROBASSOMERO (TO)  
 Tel. +39 011 9241201 (4 linee r.a.)  
 Fax +39 011 9241176  
 E-Mail [info@rcv.it](mailto:info@rcv.it)  
 http://www.rcv-srl.it

# ULTRACT - UL07

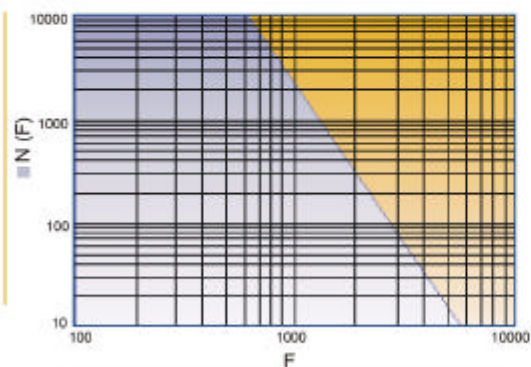
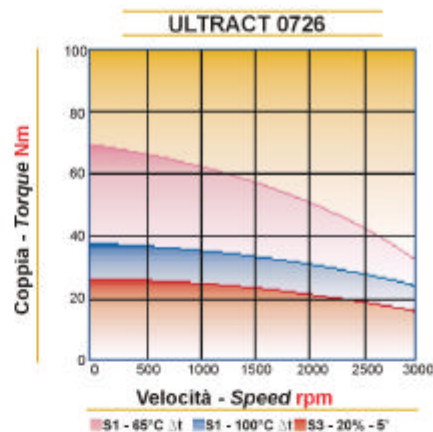
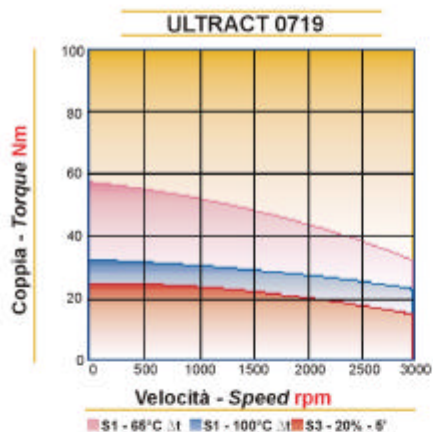
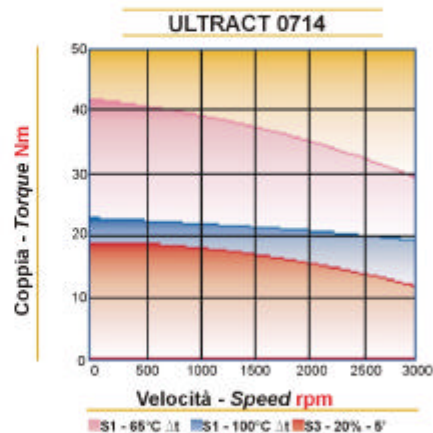
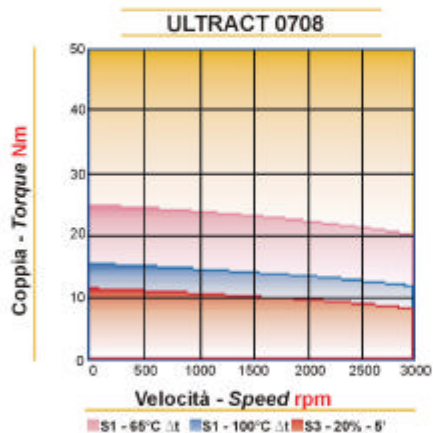

Vita (milioni di giri) dei cuscinetti in funzione del carico radiale (N) applicato alla mezzina della sporgenza d'albero del motore

Bearing calculated lifetime (million of rays) versus radial load (N) applied in the middle of the shaft

## ULTRACT - UL07

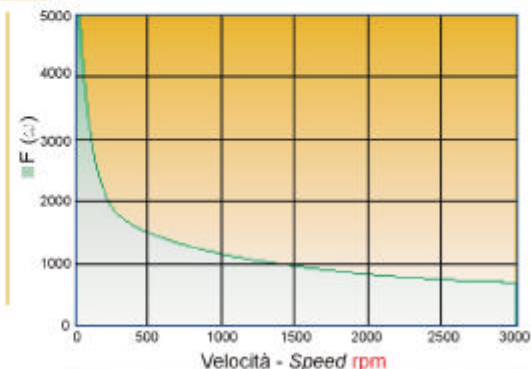

Massimo carico radiale (N) ammesso in funzione della velocità (rpm) per una vita di 30000 ore

Maximum radial load (N) versus speed (rpm) referred to 30000 h bearing lifetime