

Model	L 1	L Tot.	Model	L 1	L Tot.
UL0403	111	192	UL0403B	144	225
UL0405	154	235	UL0405B	187	268
UL0406	197	278	UL0406B	230	311
UL0408	240	321	UL0408B	273	354

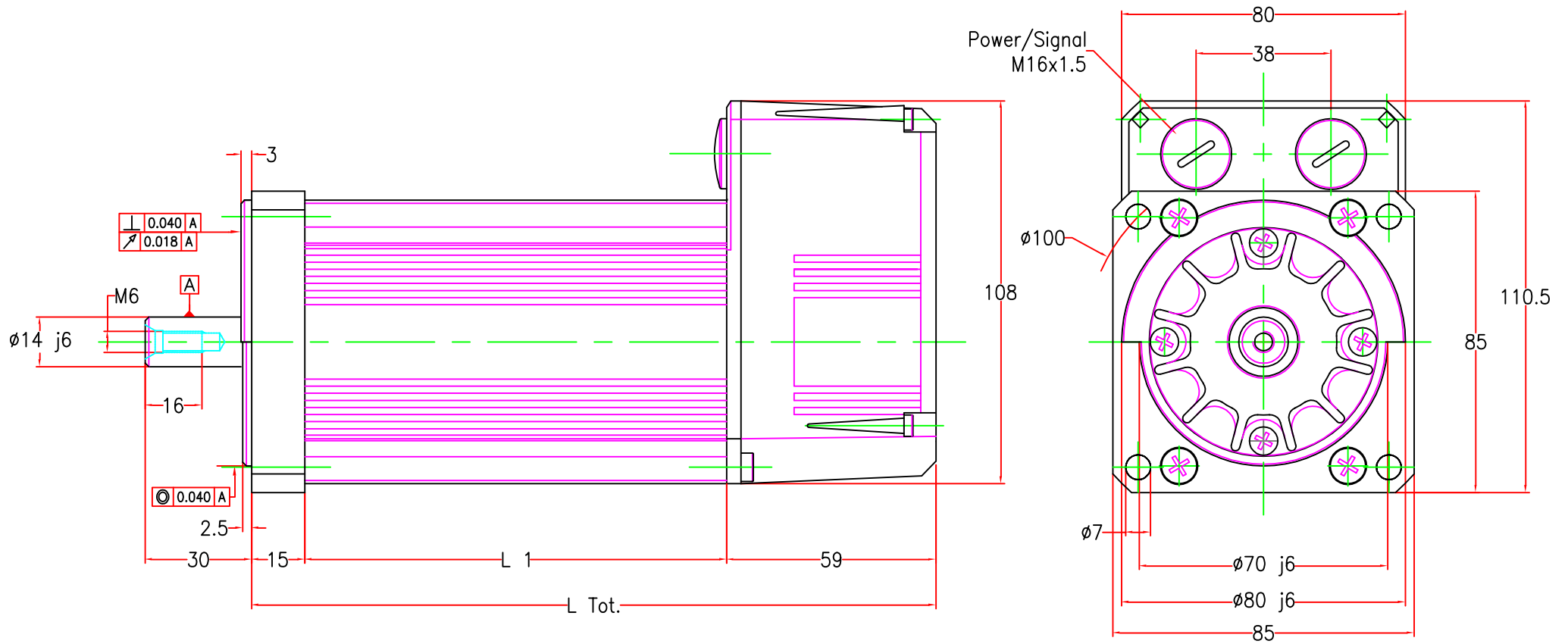

R.C.V. s.r.l.
 V. Cavour, 7 z.i.
 10070 Robassomero (TO) I
 Tel. 0039.0119241201
 Fax 0039.0119241176
 E-Mail: tecnico@rcv-srl.it



Model	L 1	L Tot.	Model	L 1	L Tot.
UL0403	119	193	UL0403B	162	236
UL0405	162	236	UL0405B	205	279
UL0406	205	279	UL0406B	248	322
UL0408	248	322	UL0408B	291	365



R.C.V. s.r.l.
V. Cavour, 7 z.i.
10070 Robassomero (TO) I
Tel. 0039.0119241201
Fax 0039.0119241176
E-Mail: tecnico@rcv-srl.it



R.C.V. srl

V. Cavour, 7 z.i.
10070 ROBASSOMERO (TO)
Tel. +39 011 9241201 (4 linee r.a.)
Fax +39 011 9241176
E-Mail info@rcv-srl.it
http:// www.rcv-srl.it

ULTRACT - UL04

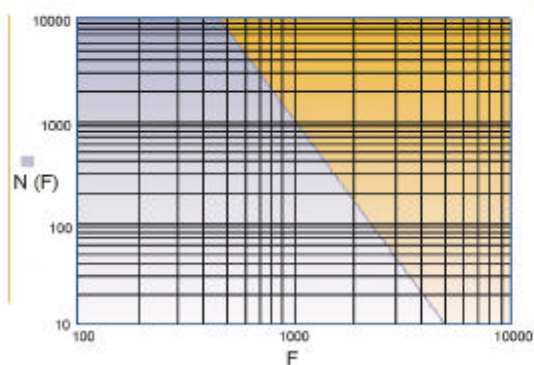
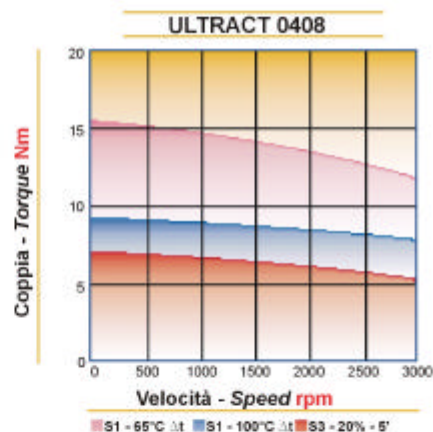
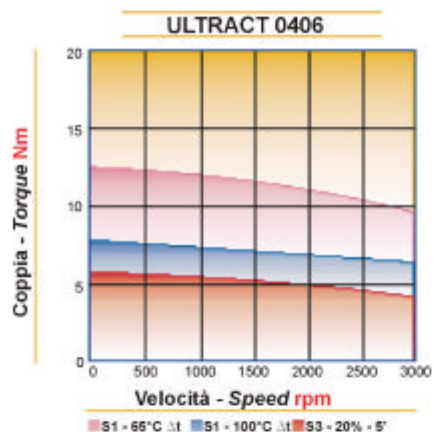
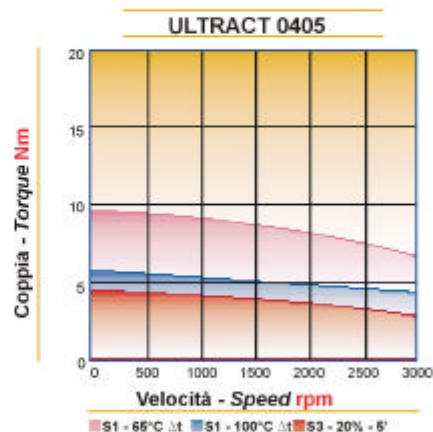
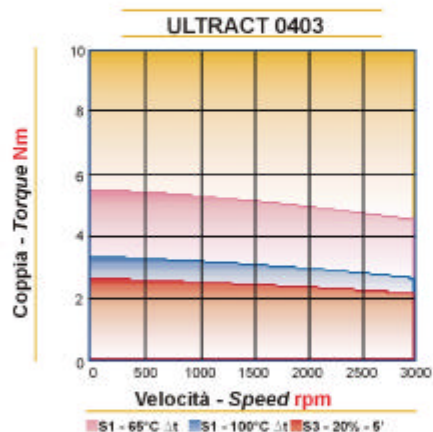

Vita (milioni di giri) dei cuscinetti in funzione del carico radiale (N) applicato alla mezziera della sporgenza d'albero del motore

Bearing calculated lifetime (million of rays) versus radial load (N) applied in the middle of the shaft

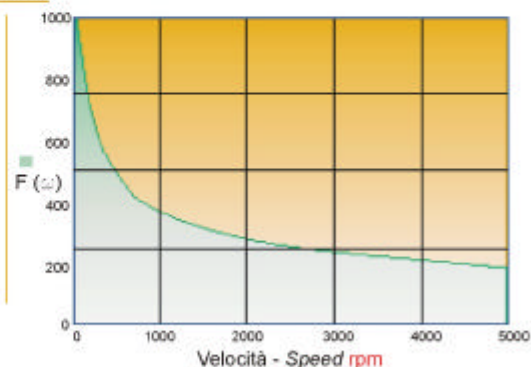

Massimo carico radiale (N) ammesso in funzione della velocità (rpm) per una vita di 30000 ore

Maximum radial load (N) versus speed (rpm) referred to 30000 h bearing lifetime